

DEADBOLTS

SINGLE CYLINDER

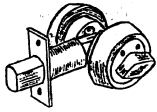

It is highly recommended that all exterior doors be equipped with a good quality deadbolt lock. A deadbolt should have the following:

1. A solid, case-hardened steel cylinder guard; a rotating cylinder guard is even better.
2. A bolt that protrudes at least 1 inch.
3. Case-hardened fasteners to hold both pieces of the lock securely to the door.

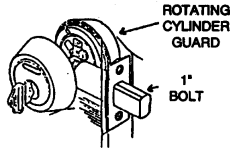

RIM LOCK

Another excellent lock is the rim lock or vertical deadbolt. It comes in single or double cylinder

varieties and features two vertical deadbolts that slide into hardened metal hasps attached to the door jamb. This type of lock cannot be slipped, forced with a wrench, or pried open.

Another type of rim lock utilizes a large, horizontal, sliding bar. It is less expensive than other types but equally effective. However, both of these locks are only as strong as the screws that attach them to the doorframe.

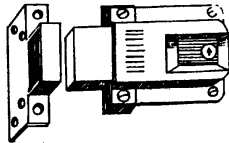

"JIMMY PROOF" RIM LOCK

CASEMENT WINDOWS

Casement windows secure best when the latch works properly and the window shuts tightly. Removing the window makes it harder on the thief if he should break the glass to open the window.



Drill a small hole through the latch frame and the latch handle. A metal pin or small padlock can be inserted, locking the latch closed.

SLIDING WINDOWS

There are several types of anti-slide locks available for securing sliding windows. Metal pins, screws and lag bolts can also be used. Do not use a lock that is difficult to remove on a window that is an emergency exit.

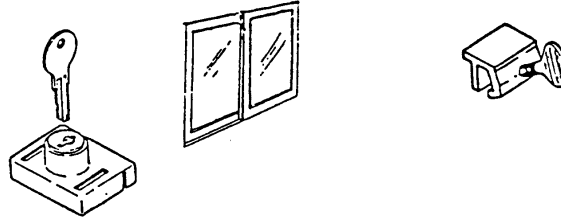

Install wood screws in the upper track above the window. The screw heads should just clear the window, allowing it to slide, but not lift. A wood dowel the appropriate diameter can be used in place of the screws. The dowel should be the same width as the sliding portion of the window.

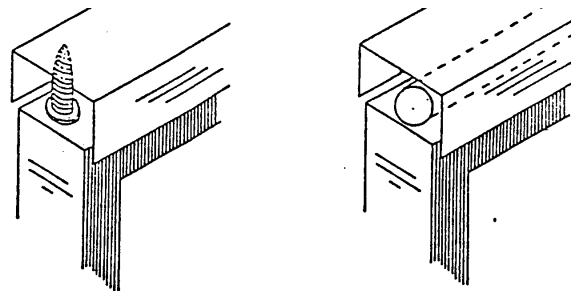

For more information on home security, or to start a Neighborhood Watch in your area, contact the Mesa Police Department at (480) 644-2300, option 5 and ask to speak with your crime prevention officer.

LOCKS



This information is meant to be an aid to the homeowner in securing the home against possible theft.

By using these suggestions, we do not guarantee that you will not be a victim of a burglary or theft.

Mesa Police Department
480-644-2300
www.mesaaz.gov/police

DOOR HINGES

Many homes have doors which open to the outside, exposing the hinge pins. Despite your good strong lock, the burglar can remove the pins and lift the door from the frame.

There are hinges which have non-removable pins or hinges containing set screws to prevent pin removal.

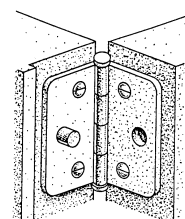

To prevent this, remove two opposing screws from each leaf of the hinge. Screw a lag bolt into the jamb, sawing off the head. Or use a headless nail, leaving 1/2 inch of the nail or bolt protruding. Drill out the opposite hole in the jamb leaf. Do this to both top and bottom hinges. When the door is closed the hinge pins may be removed, but the door will remain firmly in place.

If the hinge screws do not line up with each other do the following:

1. Drive the pin into the frame just below the hinge.
2. Drill a hole in the edge of the door.
3. The hole should be larger in diameter than the pin.

This is good protection for any door, regardless of how the hinge pins have been installed.

SECURING ATTIC CRAWLWAY OPENING

Reason for security of crawlway opening: Several burglars have made easy entry into homes by crawling up into the attic then kicking down through the ceiling causing damage, plus what they steal.

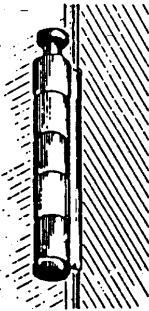

Install a 2x2 board cut the length of opening and secured with 3" to 4" screws. This will prevent cover from being raised on this end (A). Frame supporting cover should be 1x4 boards for proper strength (B). Cover board should be at least 1/2" plywood (C). Heavy duty hasp and padlock secured with bolts and nuts, not screws (D).

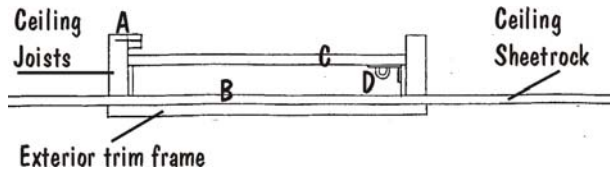

When the crawlway opening is not installed inside the home or storeroom, it should be secured by other means. Secure the crawlway with the following:

1. A solid wood or plywood cover.
2. Two hardened steel hinging hasps, or hinge one side of the door from the inside and put a hasp on the other side.
3. One or two case-hardened padlocks.

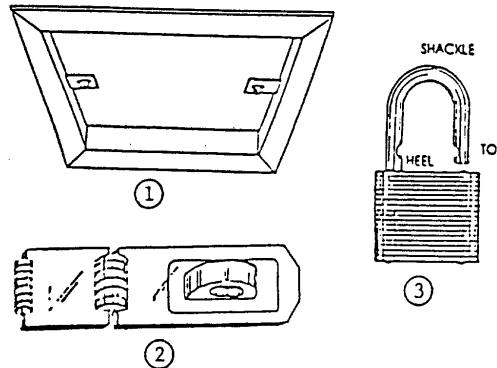

SECURITY STRIKE PLATE

The strike plates on all exterior doors should be anchored with screws 2 to 3 inches long so they reach well into the

stud. This will make it extremely difficult for a thief to kick the door open.

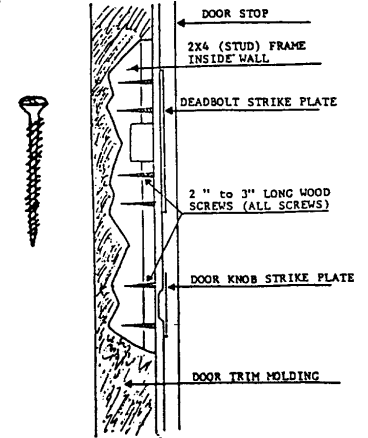
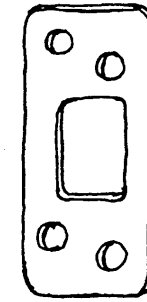

LATCH BOLT DOOR GUARD

The Blocker. The latch door guard for that added protection against forced entry attempts. It mounts to the door with four heavy-duty bolts.

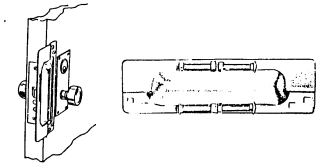

LOCKS

The spring latch lock is a privacy lock and should not be used for security. It offers no protection. The bolt can easily be slipped by a plastic credit card, fingernail file, or thin bladed knife.

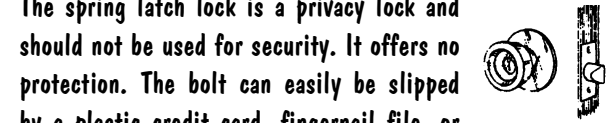

This is the same type of spring latch lock; but with the addition of a "deadbolt latch," it offers better protection against being slipped if installed correctly. However, this lock offers little protection against being forced because the burglar simply twists the doorknob off with a pipe wrench or vise grips.

